

PRODUCT IMAGE / IMAGE DU PRODUIT



GENERAL SPECIFICATIONS / SPECIFICATION GÉNÉRALES

Classification / Classification	Lithium Coin
Designation IEC / Désignation IEC	CR2016
Nominal Capacity / Capacité Nominale	85 mAh
Nominal voltage / Tension nominal	3.0V
Average weight (g) / Poids moyen (g)	1.6g
Shelf Life / Durée de vie	5 years / 5 ans
Typical Volume / Volume	0.5 cm ³

TEMPERATURE RANGE / PLAGE DE TEMPÉRATURE

Operating temperature range / Température d'utilisation	-20°C to +80°C
Recommended applications / Applications recommandées	Watch, remote, calculator

DISCHARGE CHARACTERISTICS (30 kΩ discharge load to 2.0 V)

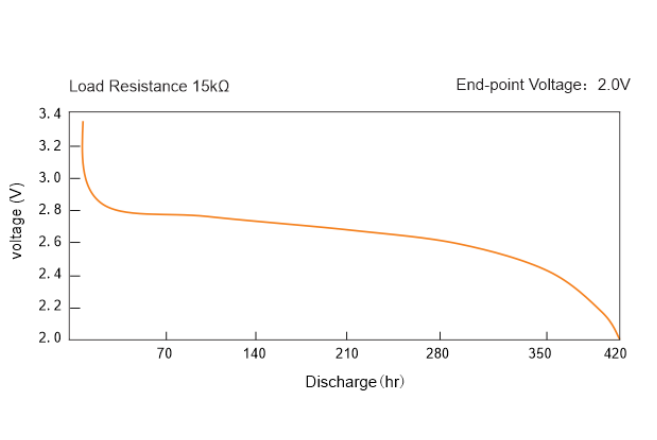

NOMINAL DIMENSION (mm)

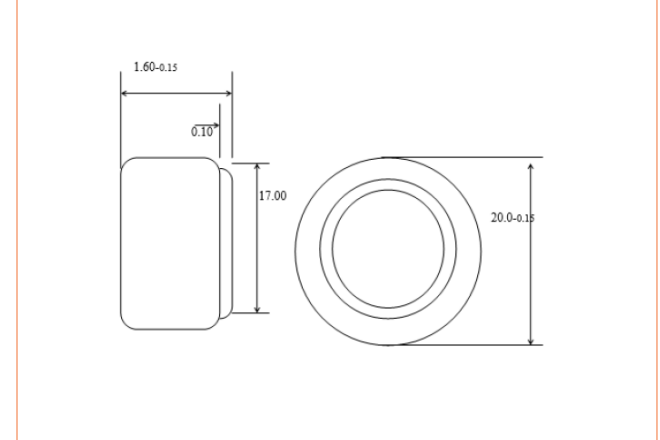

*The above information is generally descriptive only and is not intended as guarantee or warranty
 **Uniross reserves the right to alter or amend the design, model and specification without prior notice.